

Data Sheet



Article number: 12621000240000

Description: Industrial tool 621 000 240.000
For M24

Measures

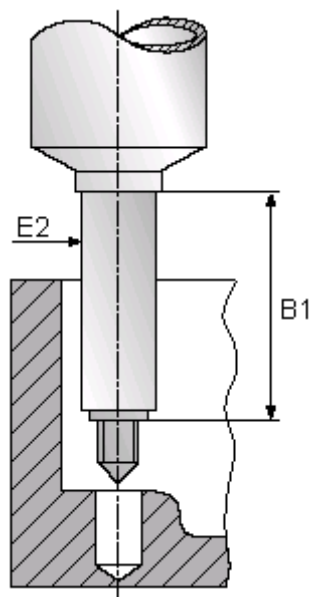

B1	= 60
E2	= 32
For thread	= M24